



High End AMT für 2-Weg Systeme. Der 25CM1.1 verbindet eine starke vertikale Bündelung mit einem breiten horizontal Abstrahlverhalten. Ideal für schallharte Böden und Decken. Gleichzeitig ist es der AMT mit der niedrigsten Übernahmefrequenz.

- Sehr niedrige Verzerrungen • Sehr flache Impedanzkurve
- Sehr tiefe Trennfrequenz • Ausgeprägte vertikale Bündelung

High End AMT for 2-way systems. The 25CM1.1 combines a strong vertical directivity with a wide horizontal dispersion. Ideal for rooms with reverberant ceilings and floors. It is also the AMT with the lowest crossover frequency.

- Very low distortion • Very flat impedance curve
- Low x-over frequency • Pronounced vertical directivity

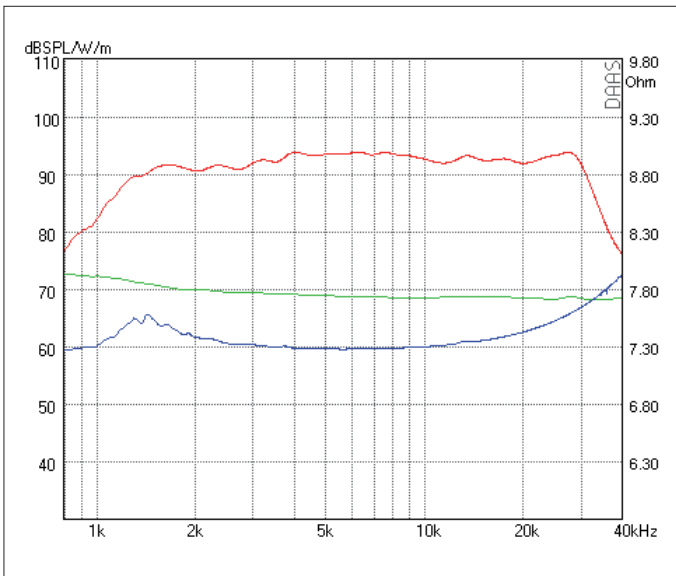

SPL 2.83 V - Phase - Impedance

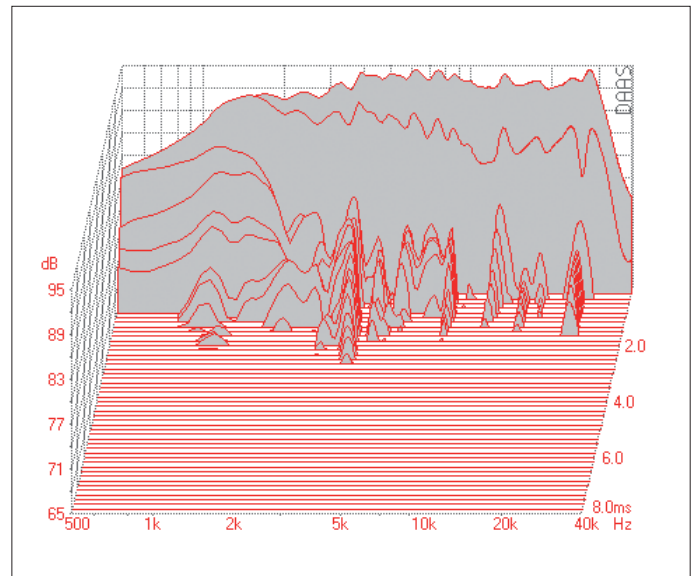

Waterfall

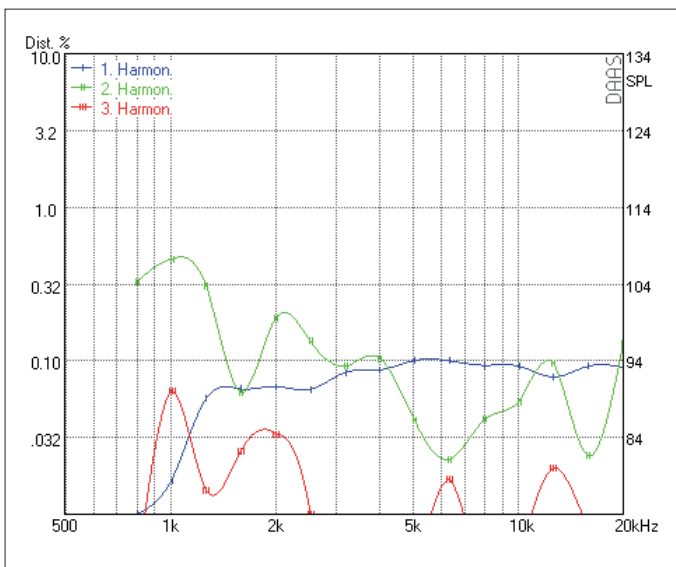

Harmonic Distortion 2.83 V

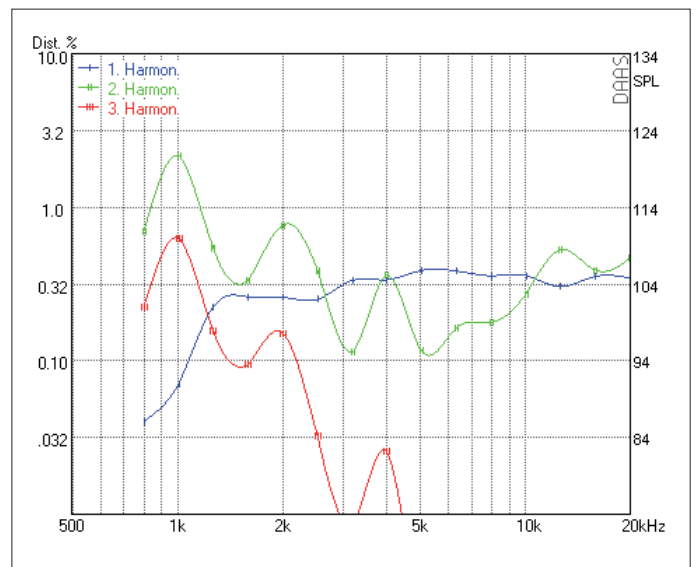

Harmonic Distortion 105 dB

RESISTANCE	NOMINAL 8 OHM		
Zo 7.6 OHM • Zmin 7.3 OHM • RE 7.3 OHM			
SENSITIVITY @ 2.83 V	93 dB		
FREQUENCY RESPONSE / -6 dB	1200 Hz – 32 kHz		
POWER HANDLING	210 W		
RESONANCE FREQUENCY / FS	1400 Hz		
RECOMMENDED CROSSOVER / 6 dB	2500 Hz		
RECOMMENDED CROSSOVER / 12 dB	2000 Hz		
DISPERSION HORIZONTAL / 15 kHz / -6 dB	70°		
DIAPHRAGM AREA	6464 mm ²		
MAGNET MATERIAL	NEODYMIUM		
FACE PLATE	3 mm Anodized Aluminum		

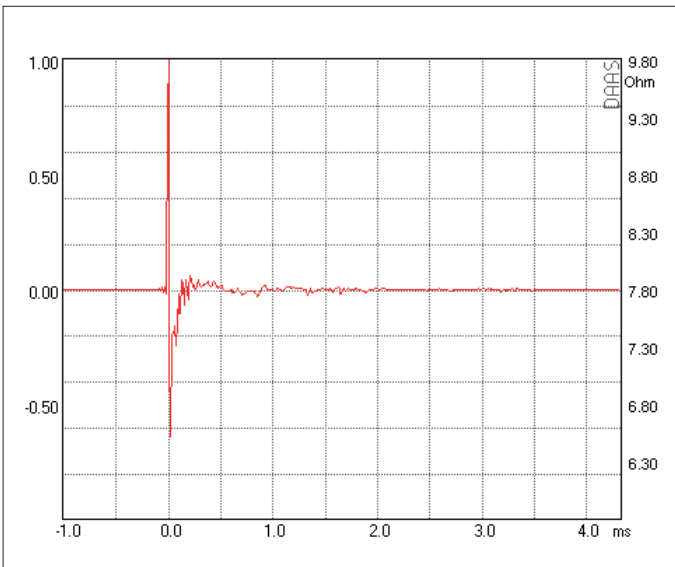
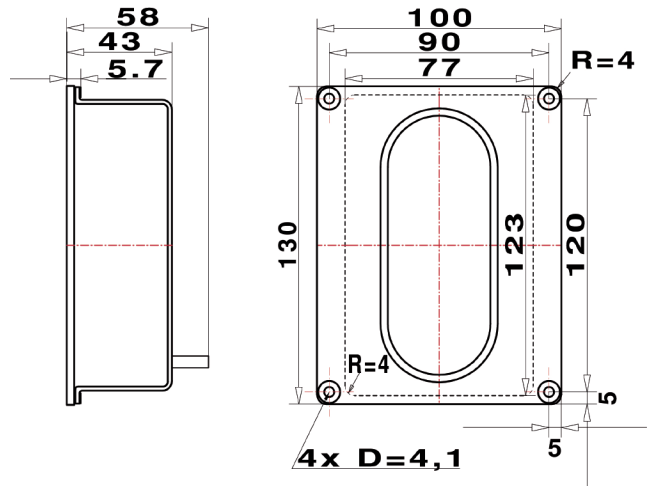

Impulse Response

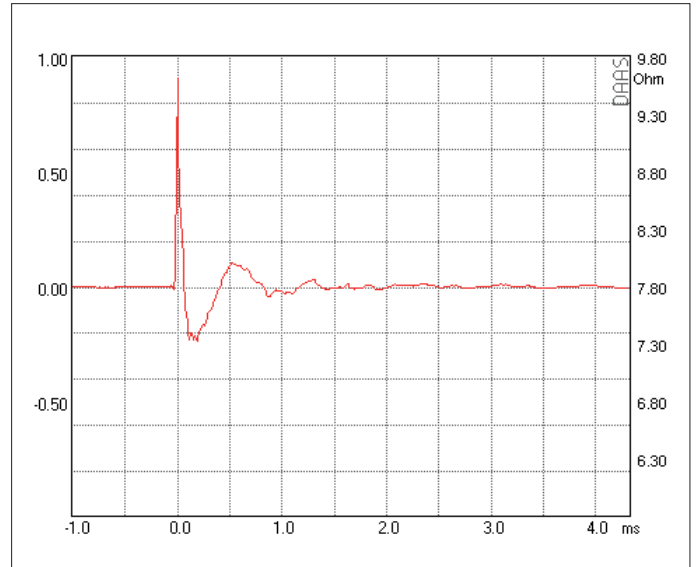

Step Response

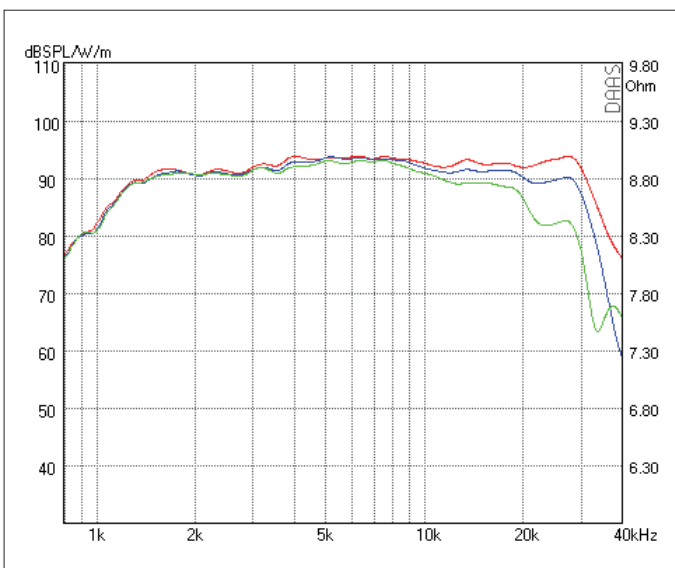

SPL HORIZONTAL 0° - 15° - 30°

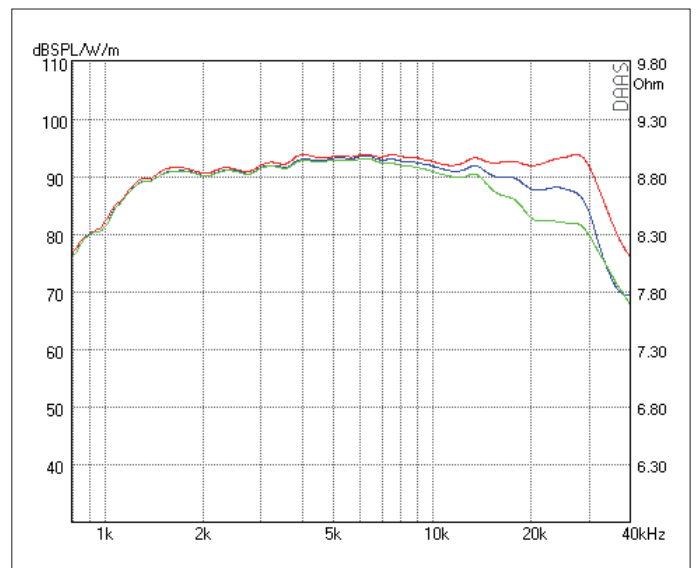

SPL VERTIKAL 0° - 5° - 15°